

Logo Here

Job # XXXXXX  
Cust # XXXX-XC

**LL6960 - Mystique Stainless Steel Vacuum Bottle: Black/Black, Navy Blue/Black & White/Grey**

Roll Print  PMS XXXc

Special icons if required

Laser Engrave 

Direct Digital 

Rotary Digital 

BELOW IS 50% OF SIZE

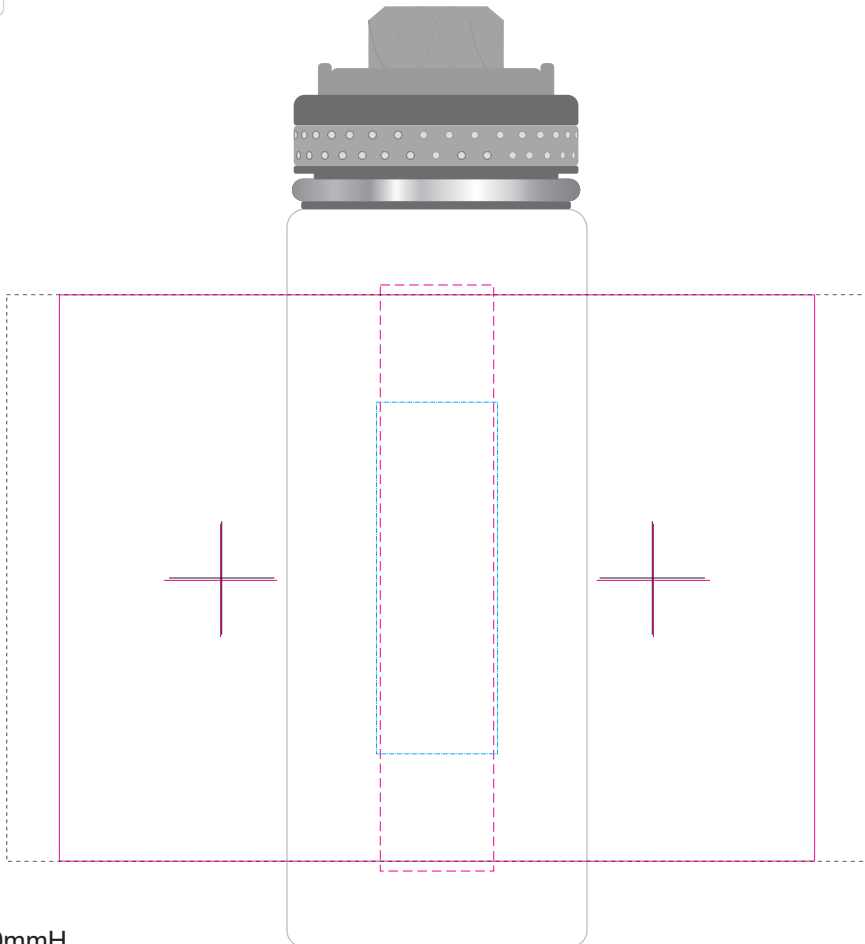





**Roll**  
Print Area: 200mmL x 150mmH  
Actual print size: xxmmL x xxmmH

**Digital**  
Print Area: 30mmL x 155mmH  
Actual print size: xxmmL x xxmmH

**Digital Rotary - Joined Wrap**  
Print area: 227.77mmL x 150mmH  
Actual print size: xxmmL x xxmmH

**Laser - Min Thickness required is 0.7mm**  
Print Area: 32mmL x 90mmH  
Actual print size: xxmmL x xxmmH



Finished print area - Roll/Screen	
Finished print area - Digital	
Finished print area - Digital Rotary	
Finished print area - Laser	
Approx opposite positions	

INT: \_\_\_\_\_  
RPT SO: \_\_\_\_\_  
QC: \_\_\_\_\_

Roll Print  PMS XXXc

Laser Engrave 

Direct Digital 

Rotary Digital 

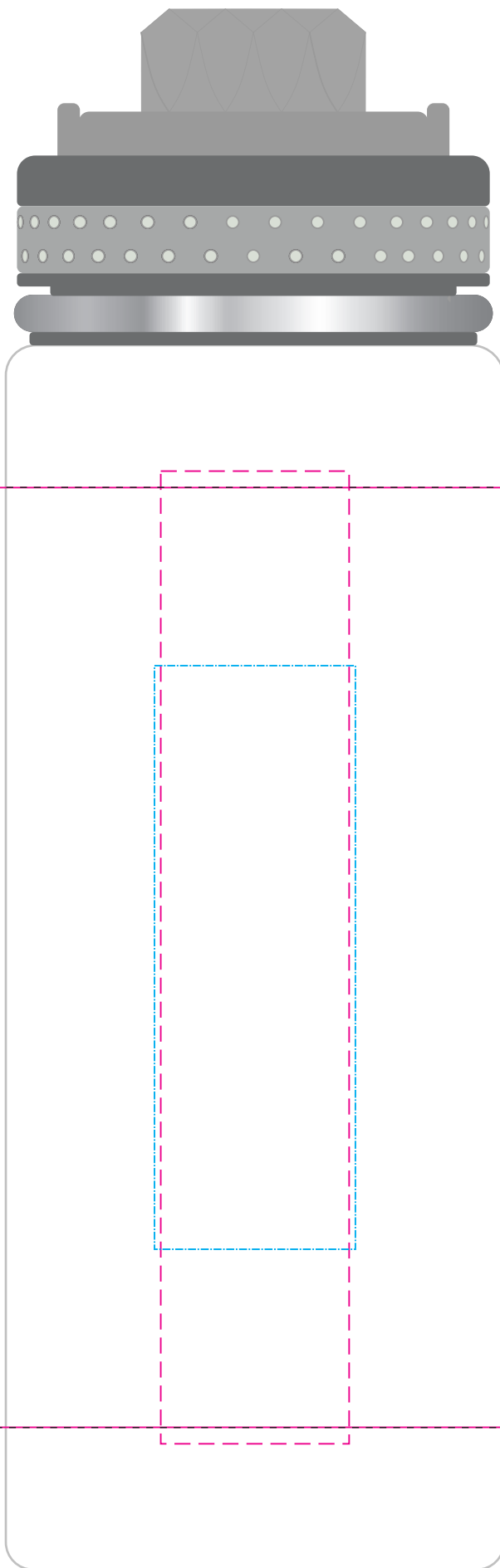

**Roll**

Print Area: 200mmL x 150mmH  
Actual print size: xxmmL x xxmmH

**Digital**





Print Area: 30mmL x 155mmH  
Actual print size: xxmmL x xxmmH

**Digital Rotary - Joined Wrap**

Print area: 227.77mmL x 150mmH  
Actual print size: xxmmL x xxmmH

**Laser - Min Thickness required is 0.7mm**

Print Area: 32mmL x 90mmH  
Actual print size: xxmmL x xxmmH

Finished print area - Roll/Screen   
Finished print area - Digital   
Finished print area - Digital Rotary   
Finished print area - Laser   
Approx opposite positions 



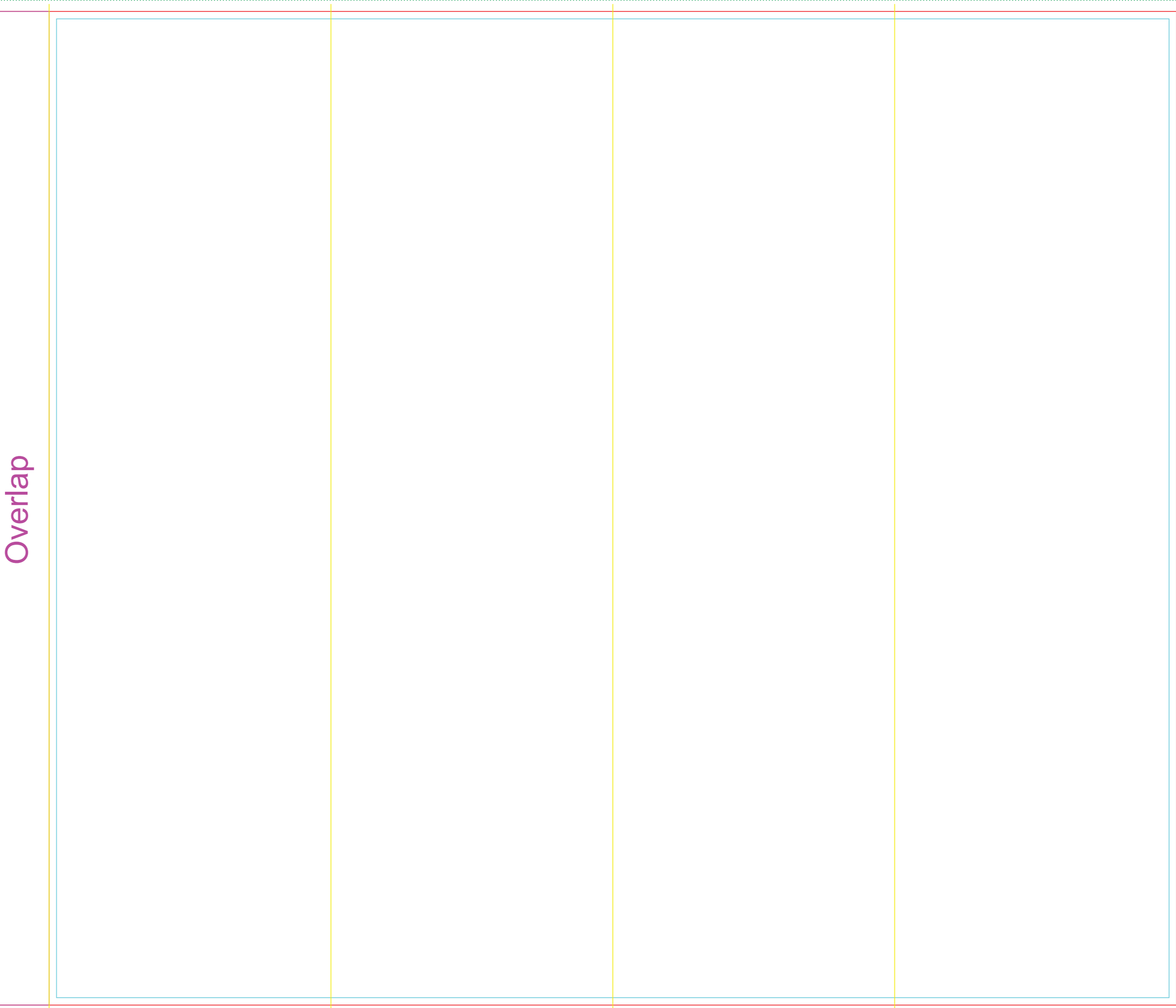

Overlap

**Sleeve**  
Print Area: 320mmL x 268mmH  
Actual print size: mmL x mmH

Max print area for copy & text	
Finished print area	
Folds	
Bleed Requirement	