

LL0863 - Milano Vaccum Cup - White, Silver & Black

Roll Print  PMS XXXc

Designs printed onto tapered products using Rotary Digital will follow the shape of the product due to the machines printing process.

Laser Engraved

Direct Digital 

Rotary Digital 



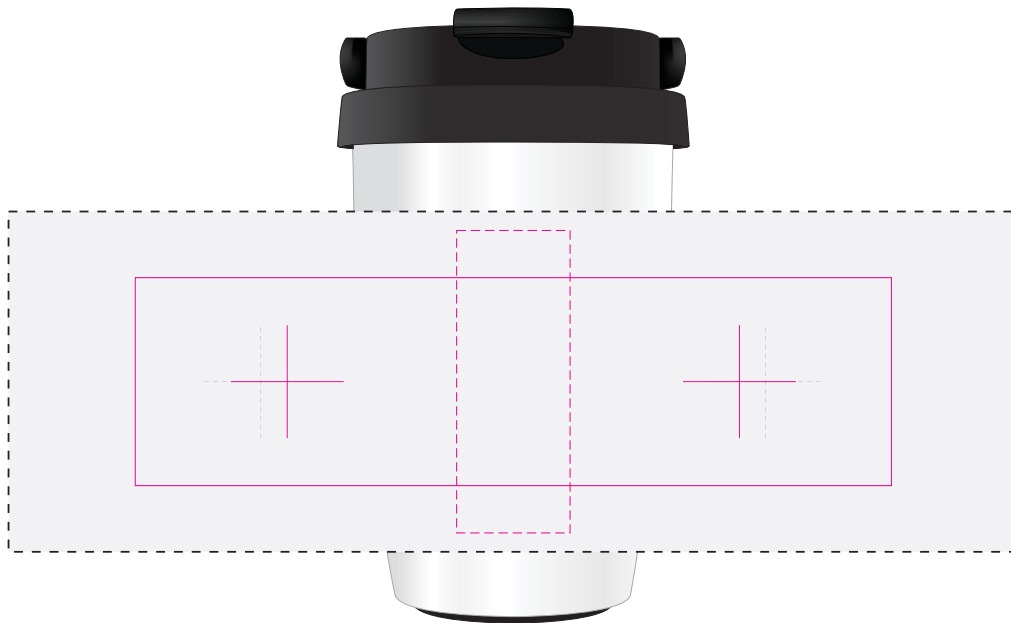

Below showing at 50%



Roll
Print Area: 200mmL x 55mmH
Actual print size: xxmmL x xxmmH

Digital/Laser
Print Area: 30mmL x 80mmH
Actual print size: xxmmL x xxmmH

Digital Rotary - Joined Wrap
Print area: 267.04mmL x 90mmH
Actual print size: xxmmL x xxmmH

Finished print area - Pad 
 Finished print area - Digital/Laser 
 Finished print area - Digital Rotary 
 Approx opposite positions 



Roll Print  PMS
XXXc

Laser Engraved

Direct Digital 

Rotary Digital 

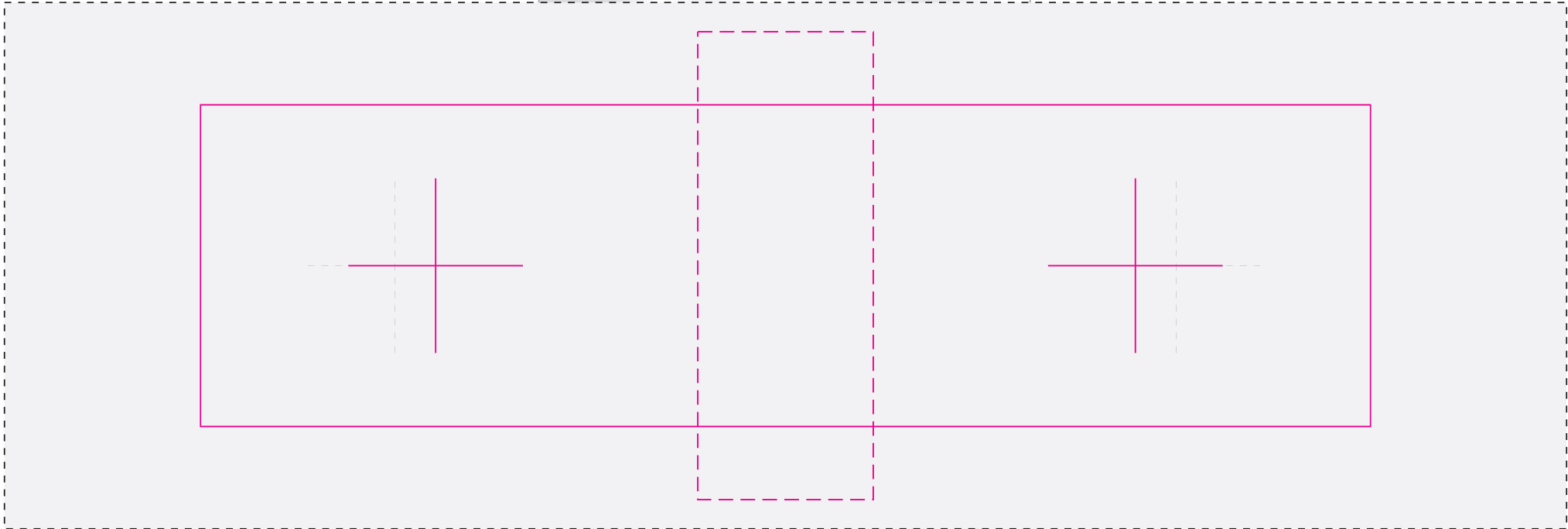

Roll





Print Area: 200mmL x 55mmH
Actual print size: xxmmL x xxmmH

Digital/Laser

Print Area: 30mmL x 80mmH
Actual print size: xxmmL x xxmmH

Digital Rotary - *Joined Wrap*

Print area: 267.04mmL x 90mmH
Actual print size: xxmmL x xxmmH

Finished print area - Pad 
Finished print area - Digital/Laser 
Finished print area - Digital Rotary 
Approx opposite positions 



Direct Digital

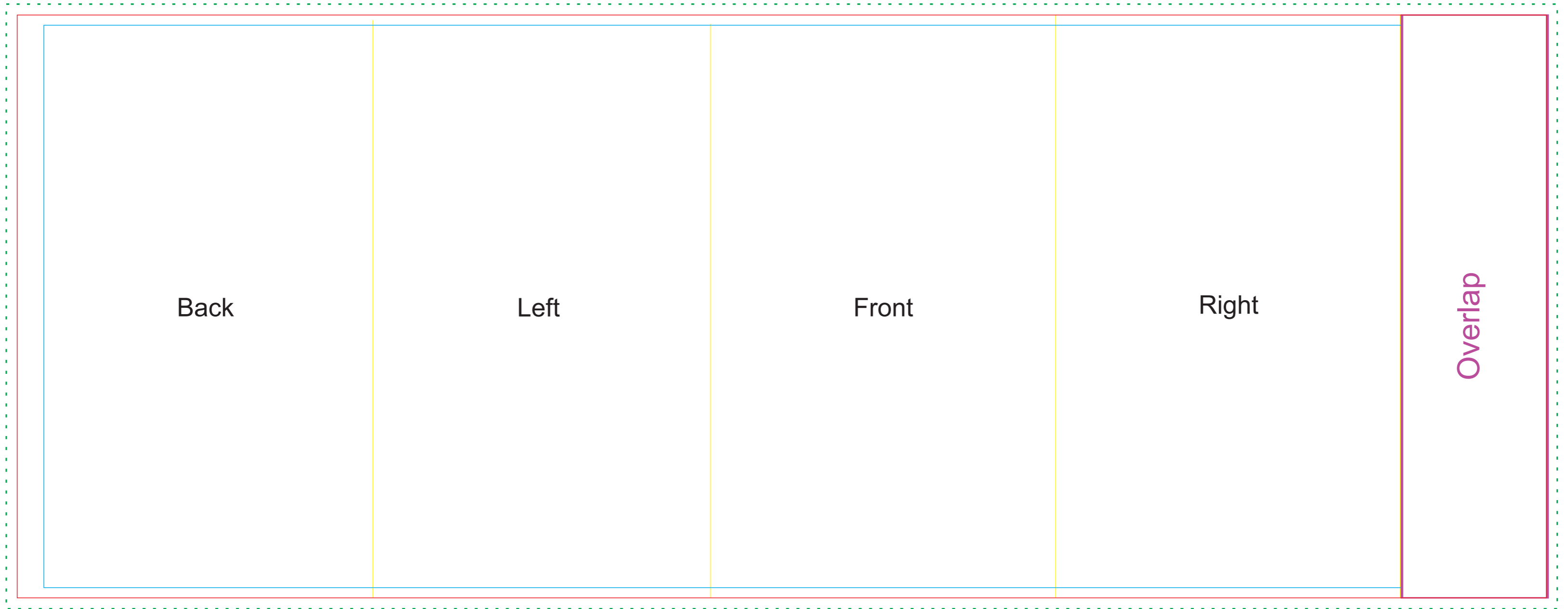

Sleeve

Print area: 420mmL x 160mmH

Actual print size: xxmmL x xxmmH

Finished print area	—
Print area for text & copy	—
Bleed	—
Folds	—
Overlap	—